

Part Number: PT427-89060
PT427-8906B

NOTE: Part number of this accessory may not be the same as the part number shown.

Kit Contents

Item #	Quantity Reqd.	Description
1	1	Hood protector
2	1	Hardware bag

Hardware Bag Contents

Item #	Quantity Reqd.	Description
1	4	Outside hood bracket
2	2	Grill hood bracket
3	2	Grill Hook bracket
4	4	6-32 well nut
5	4	6-32 x 0.5 MS
6	4	#6 SS flat washer
7	6	10-24 MS
8	4	Mylar pad - small
9	2	Double-sided tape
10	2	Mylar pad – large

Additional Items Required For Installation

Item #	Quantity Reqd.	Description

Conflicts

--

Recommended Tools

Personal & Vehicle Protection	Notes
Vehicle Protection	Blanket
Special Tools	Notes
None	
Installation Tools	Notes
Screwdriver	Phillips, #2
Ratchet	Phillips #2 Bit
Special Chemicals	Notes
Cleaner	Soap and Water

General Applicability

Note-

Recommended Sequence of Application





Item #	Accessory
1	
2	
3	

*Mandatory

Vehicle Service Parts (may be required for reassembly)

Item #	Quantity Reqd.	Description
1		
2		
3		

Legend

	STOP: Damage to the vehicle may occur. Do not proceed until process has been complied with.
	OPERATOR SAFETY: Use caution to avoid risk of injury.
	CAUTION: A process that must be carefully observed in order to reduce the risk of damage to the accessory/vehicle and to ensure a quality installation.
	TOOLS & EQUIPMENT: Used in Figures calls out the specific tools and equipment recommended for this process.

Care must be taken when installing this accessory to ensure damage does not occur to the vehicle. The installation of this accessory should follow approved guidelines to ensure a quality installation.



These guidelines can be found in the "Accessory Installation Practices" document.

This document covers such items as:-

- Vehicle Protection (use of covers and blankets, cleaning chemicals, etc.).
- Safety (eye protection, rechecking torque procedure, etc.).
- Vehicle Disassembly/Reassembly (panel removal, part storage, etc.).
- Electrical Component Disassembly/Reassembly (battery disconnection, connector removal, etc.).

Please see your Toyota dealer for a copy of this document.

1. Pre-installation Preparation.

- (a) Inspect and verify the kit contents.
- (b) Open the hood.
-  (c) Make sure front edge of hood and grill, where the deflector is to be installed, is clean and free from dirt and/or debris using soap and water.
-  (d) Cover engine bay completely with a protective blanket to catch any dropped hardware.

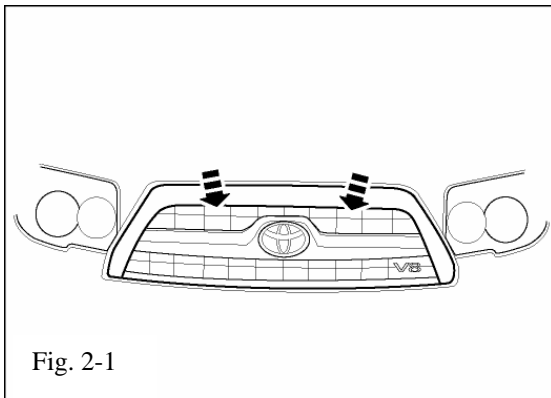

2. Mylar Pad Installation.

-  (a) Install the two (2) large mylar pads to underside of grill. Install the pads third slot from center on either side. (Fig. 2-1).
- (b) Install four (4) mylar pads to the outer bracket sections. Align with holes in hood. (Fig. 2-2).

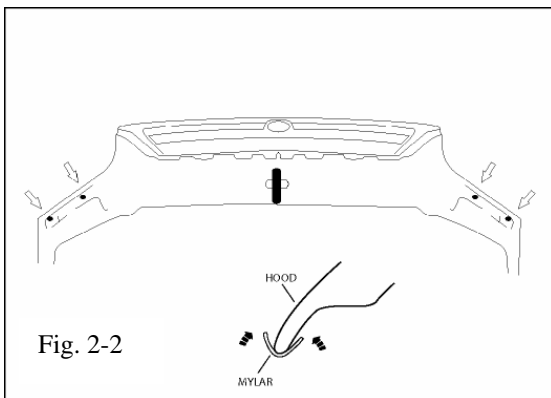

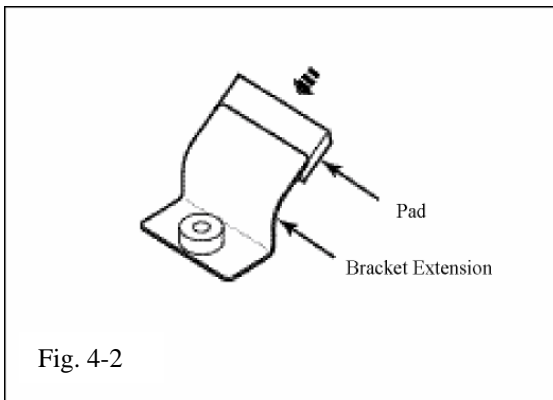
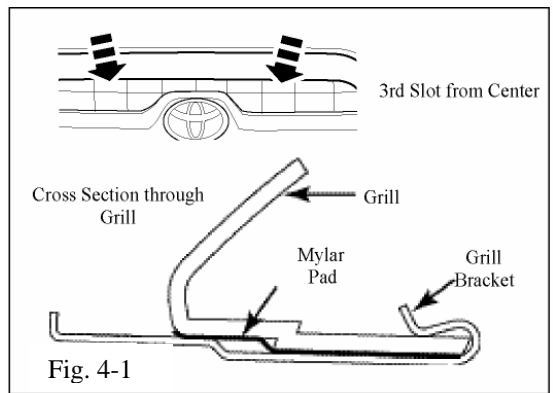
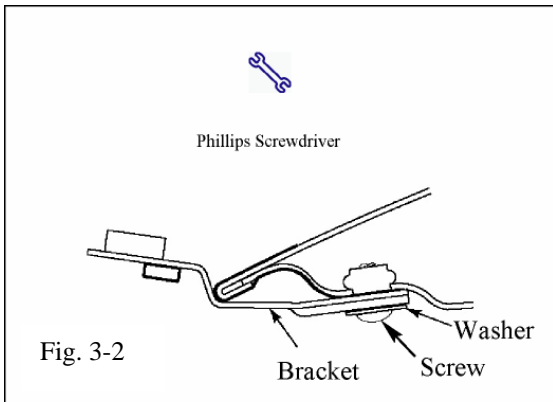
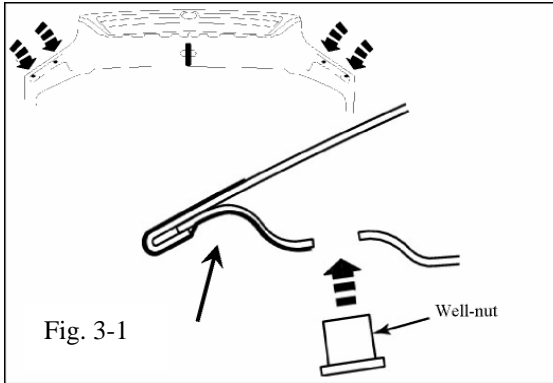

3. Outer Bracket Installation.



(a) Install four (4) well nuts into the outer holes. (Fig. 3-1).

(b) Install the outside hood brackets in the locations shown (Fig. 3-2).



(c) Attach the bracket to the hood using the 6-32 x 1/2" screw and washer. The washer goes between the screw head and bracket. (Fig. 3-2)

4. Grill Bracket Installation



(a) Insert Grill Hook Brackets into the third slot from center on either side. Make sure brackets are centered in the slot. (Fig. 4-1)



(b) Apply the double-sided tape to the Grill Hood Bracket. Remove paper backing from one side only. Apply this side towards the bracket, and align pad along top edge and sides of bracket extension. (Fig. 4-2).

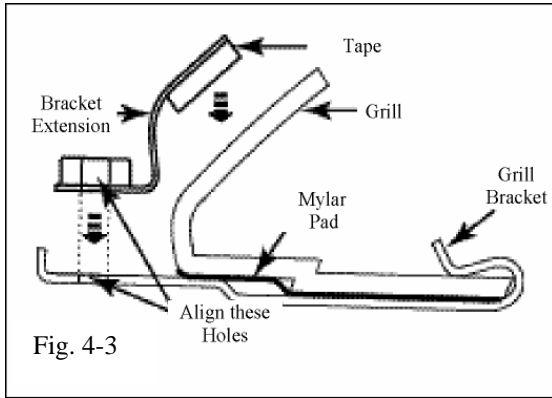

- (c) Attach Grill Hood Brackets to the Grill Hook brackets. Remove paper backing from double-sided tape and adhere to grill, make sure the holes in both brackets (grill and extension) line up. (Fig. 4-3).

5. Install the Shield Assembly to the Vehicle

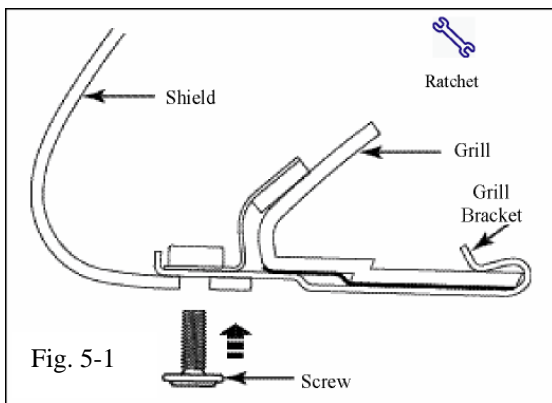

- (a) Attach shield to grill brackets using two (2) – 1/2” (10-24) screws. Hand start the screws. (Fig. 5-1).
- (b) Peel back protective film from shield in location where screws attach to brackets.
- (c) Line up shield with the grill brackets making sure the shield is centered. The center "V" nib on the inner edge of the shield should align with the center rib on the grill (Fig. 5-2).

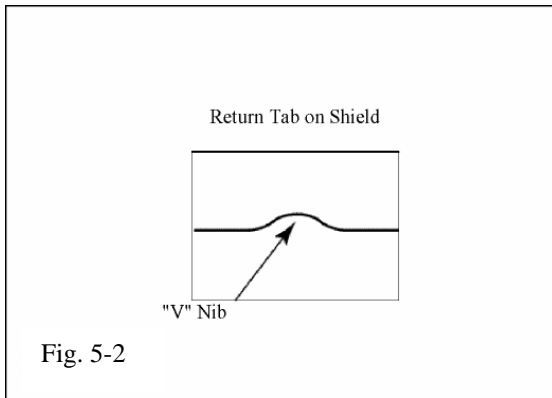

- (d) Line up shield with the outer hood brackets once again making sure the shield is centered.
- (e) Screw shield to outer brackets using four (4) 10-24 x 1/2” screws. Hand start screws (Fig 5-3).

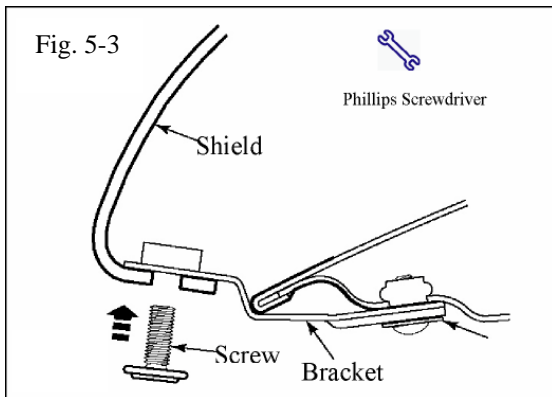

- (f) Make sure the shield is centered and all six (6) screws are tight.
- (g) Close the hood.
- (h) Remove entire protective film from shield and discard film.

TOYOTA 4RUNNER 2006 - HOOD PROTECTOR

Checklist - these points **MUST** be checked to ensure a quality installation.

Check:

Look For:

Accessory Function Checks

- Inspect brackets
- Inspect screws
-  Screw tightness

- Hood closure.

- Clearance of hood protector to hood.

- Six brackets installed on hood.

- Six screws installed on hood protector

- Six screws holding hood protector to brackets are firmly tightened.

- Outside Hood brackets should not contact the headlights.

- The hood protector (shield) should not contact the grill.